

## THE SELF AND MUTUAL INDUCTANCES OF LINEAR CONDUCTORS.

---

By Edward B. Rosa.

---

Formulæ for the self and mutual inductances of straight wires and rectangles are to be found in various books and papers, but their demonstrations are usually omitted and often the approximate formulæ are given as though they were exact. I have thought that a discussion of these formulæ, with the derivation of a number of new expressions, would be of interest, and that illustrations of the formulæ, with some examples, would be of service in making such numerical calculations as are often made in scientific and technical work.

I have derived the formulæ in the simplest possible manner, using the law of Biot and Savart in the differential form instead of Neumann's equation, as it gives a better physical view of the various problems considered. This law has not, of course, been experimentally verified for unclosed circuits; but the self-inductance of an unclosed circuit means simply its self-inductance as a part of a closed circuit, the total inductance of which can not be determined until the entire circuit is specified. In this sense the use of the law of Biot and Savart to obtain the self-inductance of an unclosed circuit is perfectly legitimate. I have also shown how, by the use of certain arithmetical mean distances in addition to geometrical mean distances, the accuracy of some of the formulæ can be increased.

In the following demonstrations the magnetic field is assumed to be instantaneous; in other words, the dimensions of the circuit are assumed to be small enough and the frequency of the current slow

enough so that it is not necessary to take account of the finite velocity of propagation of the field. This may be done even when the field is integrated to infinity, as the distant magnetic field is canceled when two or more open circuits are combined into a closed circuit.<sup>1</sup>

### 1. SELF-INDUCTANCE OF A STRAIGHT CYLINDRICAL WIRE.

Let AB be a length  $l$  of a cylindrical wire of radius  $\rho$  traversed by current  $i$  distributed uniformly over the cross section of the wire.

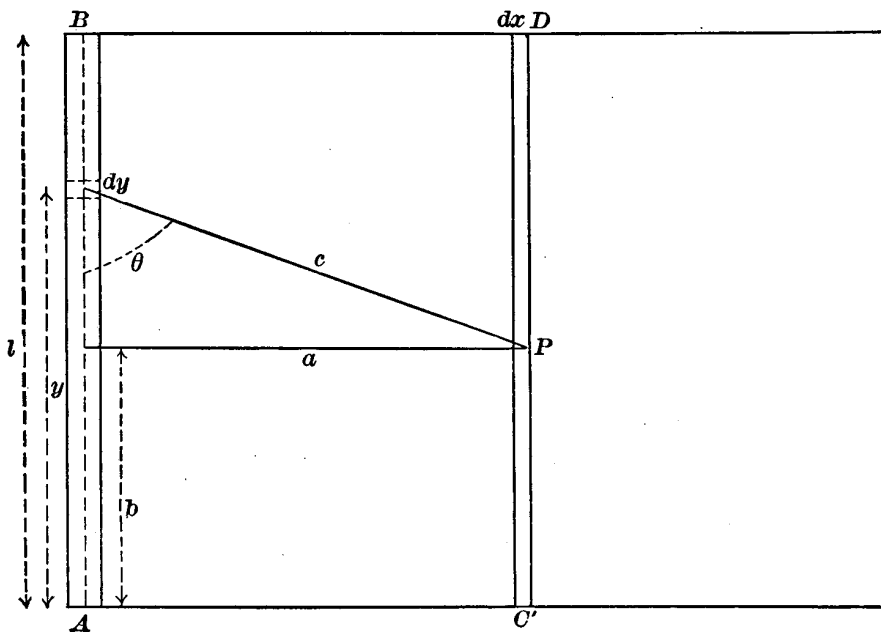

Fig. 1.

The magnetic force at P normal to the paper due to an element of the cylinder of length  $dy$  is,

$$i \frac{dy}{c^2} \sin \theta = \frac{i a dy}{[a^2 + (y-b)^2]^{\frac{3}{2}}}$$

It is easy to show<sup>2</sup> that the force at any point outside a right cylinder is the same as though the current were concentrated at the

<sup>1</sup> For a discussion of the self-inductance of an open circuit closed by displacement currents in which the finite velocity of the field is taken into account see a recent paper by K. Ogura and C. P. Steinmetz, *Phys. Rev.*, **25**, p. 184, Sept., 1907.

<sup>2</sup> Minchin, *London Electrician*, Sept. 27, 1895.

M. Wien, *Wied. Annal.* **53**, p. 928, 1894, gives a number of formulae for the self and mutual inductance of linear conductors.

axis of the wire. The force at P due to the whole length of the cylinder carrying unit current is then,

$$H = \int_0^l \frac{a \, dy}{[a^2 + (y-b)^2]^{\frac{3}{2}}} = a \sqrt{a^2 + (l-b)^2} + \frac{b}{a \sqrt{a^2 + b^2}} \tag{1}$$

The number of lines of magnetic force  $dN$ , within the strip CD, of breadth  $dx$ , is found by integrating the expression for  $H$  along the strip.

Thus,

$$\begin{aligned} dN &= \frac{dx}{a} \int_0^l \left[ \frac{l-b}{\sqrt{a^2 + (l-b)^2}} + \frac{b}{\sqrt{a^2 + b^2}} \right] db \\ &= \frac{2dx}{a} \left[ \sqrt{a^2 + l^2} - a \right] \end{aligned} \tag{2}$$

The whole number of lines of force  $N$  outside the wire which will collapse upon the wire when the current ceases is found by integrating  $dN$  with respect to  $x$  from  $x = \rho$  to  $x = \infty$ . Thus, replacing  $a$  by  $x$  in (2),

$$N = 2 \int_{\rho}^{\infty} \left[ \frac{\sqrt{x^2 + l^2}}{x} - 1 \right] dx = 2 \left[ \sqrt{x^2 + l^2} - x - l \log \frac{l + \sqrt{x^2 + l^2}}{x} \right]_{\rho}^{\infty} \tag{2a}$$

$$\text{or, } N = 2 \left[ l \log \frac{l + \sqrt{l^2 + \rho^2}}{\rho} - \sqrt{l^2 + \rho^2} + \rho \right] \tag{3}$$

$$= 2l \left[ \log \frac{2l}{\rho} - 1 \right] \text{ approximately} \tag{4}$$

This is the number of lines of force outside the wire due to unit current in the wire, and is therefore that part of its self-inductance  $L_1$  due to the external field. We must now find  $L_2$  due to the field within the wire.

The strength of field at the point P within the wire is  $\frac{2ix}{\rho^2}$ . The number of lines of force in the length  $l$  within the element  $dx$  is, therefore,

$$dN = \frac{2ilx \, dx}{\rho^2}$$

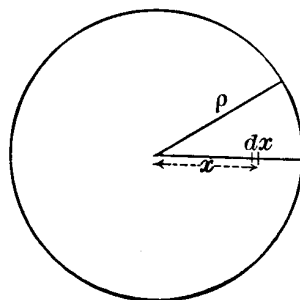

Fig. 2.

If we integrate this expression from 0 to  $\rho$  we have the whole number of lines of force within the conductor. Therefore

$$N = \frac{li}{\rho^2} \int_0^\rho 2x dx = li \quad (5)$$

Thus there are  $i$  lines or tubes per unit of length within any cylindrical conductor carrying a current  $i$ , or *one tube per cm for unit current*.<sup>3</sup>

The lines within the conductor do not cut the whole cross section of the conductor, as do those without. We must weight them, in estimating their effect on the self-inductance, in proportion to the area of the section of the conductor cut by each elementary tube.

Thus,

$$iL_2 = l \int_0^\rho \frac{2ix}{\rho^2} \cdot \frac{x^2}{\rho^2} dx = l \left[ \frac{i}{2} \cdot \frac{x^4}{\rho^4} \right]_0^\rho = \frac{li}{2}$$

or  $L_2 = \frac{l}{2}$  (6)

Thus the  $l$  lines or tubes within the conductor contribute only half as much toward the self-inductance of the conductor as an equal number of lines outside the conductor would do.

If the permeability of the wire is  $\mu$  the part of the self-inductance due to the internal field is

$$L_2 = \frac{\mu l}{2} \quad (7)$$

We may derive (6) otherwise thus: The field at P is

$$H = \frac{2ix}{\rho^2}$$

The total energy  $W$  inside the wire is

$$W = \frac{I}{8\pi} \int H^2 dv,$$

---

<sup>3</sup> For convenience we may, however, speak as though there were many lines or tubes within the conductor due to unit current.

where the integration is taken throughout the entire volume of the cylindrical wire.

Thus, since  $dv = 2\pi x l dx$

$$W = \frac{1}{8\pi} \int_0^\rho \frac{4i^2 x^2}{\rho^4} \cdot 2\pi x l dx = \frac{li^2}{\rho^4} \int_0^\rho x^3 dx = \frac{li^2}{4} \quad (8)$$

But since  $W = \frac{1}{2} L_2 i^2$ , we have

$$L_2 = \frac{l}{2},$$

as found above by the first method (6).

The total self-inductance of the length  $l$  of straight wire is therefore the sum of  $L_1$  and  $L_2$ , as given by (3) and (6), or

$$L = 2 \left[ l \log \frac{l + \sqrt{l^2 + \rho^2}}{\rho} - \sqrt{l^2 + \rho^2} + \frac{l}{4} + \rho \right] \quad (9)$$

$$= 2l \left[ \log \frac{2l}{\rho} - \frac{3}{4} \right] \text{ approximately.} \quad (10)$$

$$= 2l \left[ \log \frac{2l}{\rho} - 1 + \frac{\mu}{4} \right] \quad (11)$$

where the permeability of the wire is  $\mu$ , and that of the medium outside is unity. This formula was originally given by Neumann. For a straight cylindrical tube of infinitesimal thickness, or for alternating currents of great frequency, when there is no magnetic field within the wire, we have for the self-inductance instead of (10) or (11)

$$L = 2l \left[ \log \frac{2l}{\rho} - 1 \right] \quad (11a)$$

## 2. THE MUTUAL INDUCTANCE OF TWO PARALLEL WIRES.

The mutual inductance of two parallel wires of length  $l$ , radius  $\rho$ , and distance apart  $d$  will be the number of lines of force due to unit current in one which cut the other when the current disappears. This will be the value of  $N$  given by (2a) when the limits of integration are  $d$  and  $\infty$  instead of  $\rho$  and  $\infty$  as before.

Thus

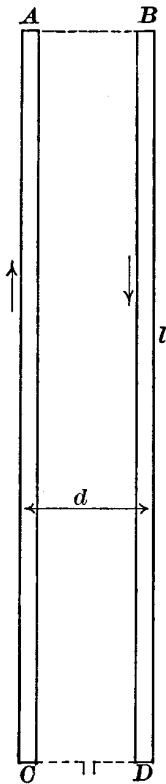

Fig. 3.

$$M = 2 \left[ l \log \frac{l + \sqrt{l^2 + d^2}}{d} - \sqrt{l^2 + d^2} + d \right] \tag{12}$$

$$= 2l \left[ \log \frac{2l}{d} - 1 + \frac{d}{l} \right] \text{ approximately} \tag{13}$$

when the length  $l$  is great in comparison with  $d$ .

Equation (12), which is an exact expression when the wires have no appreciable cross section, is not an exact expression for the mutual inductance of two parallel cylindrical wires, but is not appreciably in error even when the section is large and  $d$  is small if  $l$  is great compared with  $d$ . The force in that case due to A at all points outside A is exactly the same as though the current were concentrated at the center  $O_1$  of A; and the geometrical mean distance from  $O_1$  to the cross section of B is exactly the distance  $d$  between  $O_1$  and  $O_2$ . The *mean distance* from  $O_1$  to all the points in the section of B is not, however, quite the same as  $d$ , although the mean of the log of these distances is  $\log d$ . Hence there is a very slight difference in the last term of (12) depending upon the section of the wires and a still smaller difference in the other terms. (See p. 331.) This is, however, too small to be appreciable in any ordinary case, being a small quantity of the second order when  $l$  is large compared with  $d$ .

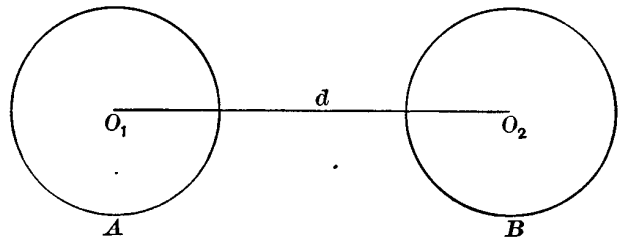

Fig. 4.

3. THE SELF-INDUCTANCE OF A RETURN CIRCUIT.

If we have a return circuit of two parallel wires each of length  $l$  (the current flowing in opposite direction in the two wires) the self-inductance of the circuit will be, neglecting the effect of the end connections shown by dotted lines, Fig. 3,

$$L = 2L_1 - 2M$$

where  $L_1$  is the self-inductance of either wire taken by itself, and  $M$  is their mutual inductance. Substituting the approximate values of  $L_1$  and  $M$  we have

$$L = 4l \left[ \log \frac{d}{\rho} + \frac{\mu}{4} \right] \text{ approximately} \quad (14)$$

The same result follows if we integrate the expression for the magnetic force between the wires due to unit current,  $H = 2/x$ .

Thus,

$$N = l \int_{\rho}^d \frac{2dx}{x} = 2l \log \frac{d}{\rho}$$

Multiplying this by two (for both wires) and adding the term due to the magnetic field within the wires we have the result given by (14). If the end effect is large, as when the wires are relatively far apart, use the expression for the self-inductance of a rectangle below (24); or, better, add to the value of (14) the self-inductance of  $AB + CD$  using equation (10) in which  $l = 2AB$ .

#### 4. MUTUAL INDUCTANCE OF TWO PARALLEL WIRES BY NEUMANN'S FORMULA.

Neumann's formula for the mutual inductance of any two circuits is

$$M = \iint \frac{\cos \epsilon \, ds \, ds'}{r} \quad (15)$$

In this case  $\epsilon = 0$  and  $\cos \epsilon = 1$ ,  $r = \sqrt{a^2 + (y-b)^2}$ , and the integration is along both lines.

$$M = \int dy' \int_0^l \frac{dy}{\sqrt{a^2 + (y-b)^2}} = \int dy' \left[ \log \frac{l-b + \sqrt{a^2 + (l-b)^2}}{\sqrt{a^2 + b^2} - b} \right]$$

The quantity in the brackets is the mutual inductance of the line  $AB$  and unit length of  $CD$  at a point distant  $b$  from the lower end, Fig. 4a. Now making  $b$  variable and calling it  $y$ , and integrating along  $CD$  from  $0$  to  $l$ , we have

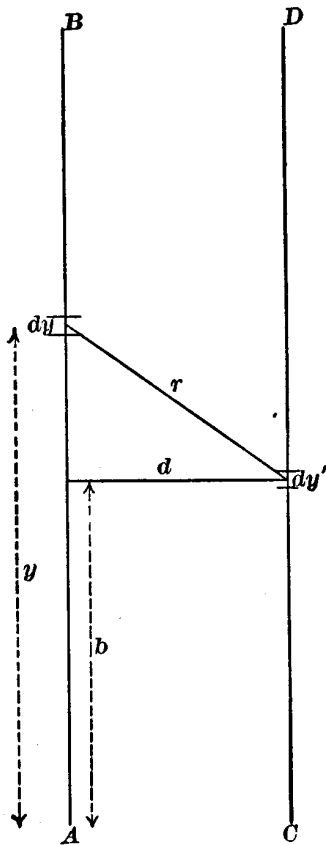

$$M = 2 \left[ l \log \frac{l + \sqrt{l^2 + d^2}}{d} - \sqrt{l^2 + d^2} + d \right]$$

which is the same expression (12) found by the other method. That process is more direct and simpler to carry out than to use Neumann's formula.

**5. MUTUAL INDUCTANCE OF TWO LINEAR CONDUCTORS IN THE SAME STRAIGHT LINE**

We have found the self-inductance of the finite linear conductor AB by integrating the magnetic force due to unit current in AB over the area ABB'A', extending to the right to infinity, equations (3) and (9).

In the same way we may find the mutual inductance of the conductors AB

Fig. 4a.

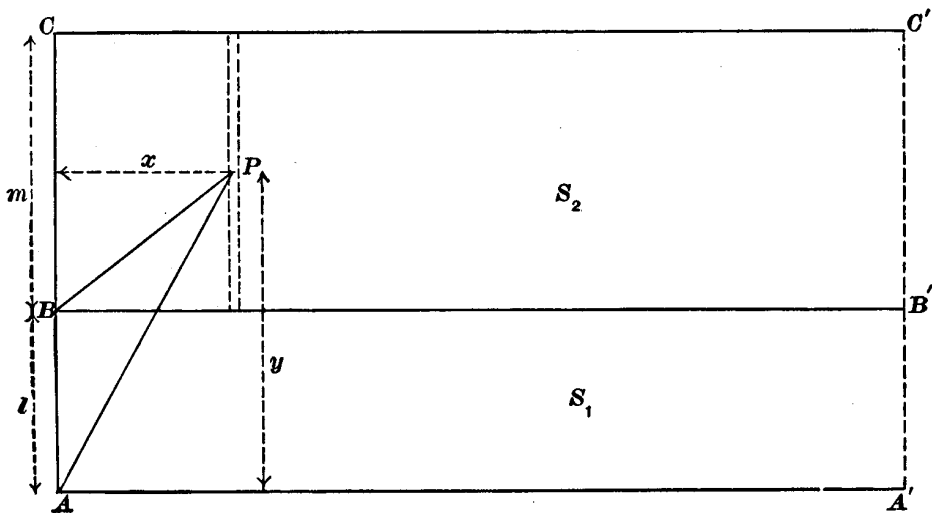

Fig. 5.

and BC, lying in the same straight line, by integrating over the area  $S_2$  (extending to infinity) the force due to unit current in AB.



The magnetic force at the point P (of coordinates  $x, y$ , origin at A) due to current  $i$  in AB is

$$H_P = i \left[ \frac{y}{\sqrt{x^2 + y^2}} - \frac{y-l}{\sqrt{x^2 + (y-l)^2}} \right] \quad (16)$$

The whole number of lines of force  $N_2$  included in the area  $S_2$  is

$$\begin{aligned} N_2 &= i \int_0^\infty \frac{dx}{x} \int_l^{l+m} \left[ \frac{y dy}{\sqrt{x^2 + y^2}} - \frac{(y-l) dy}{\sqrt{x^2 + (y-l)^2}} \right] \\ &= i \int_0^\infty \left[ \sqrt{x^2 + (l+m)^2} - \sqrt{x^2 + l^2} - \sqrt{x^2 + m^2} + x \right] \frac{dx}{x} \\ &= i \left[ \sqrt{x^2 + (l+m)^2} - \sqrt{x^2 + l^2} - \sqrt{x^2 + m^2} \right. \\ &\quad \left. + x - l \log \frac{l+m + \sqrt{x^2 + (l+m)^2}}{l + \sqrt{x^2 + l^2}} \right. \\ &\quad \left. - m \log \frac{l+m + \sqrt{x^2 + (l+m)^2}}{m + \sqrt{x^2 + m^2}} \right]_0^\infty \end{aligned}$$

or  $M_{lm} = l \log \frac{l+m}{l} + m \log \frac{l+m}{m}$ , approximately. (17)

This approximation is very close indeed so long as  $m$  does not approach infinity and the radius of the conductor BC (which we have assumed zero) is very small.

If  $l = m$ ,

$$M = 2l \log_e 2 = 2l \times 0.69315 \text{ cm.}$$

If  $m = 1000 l$ , (17) gives

$$\begin{aligned} M &= l \log_e 1001 + 1000 l \log_e 1.001 \\ &= l \log_e 1001 + l \text{ approximately.} \end{aligned} \quad (18)$$

If  $l=1$  cm, (18) gives

$$\begin{aligned} M &= \log_e 1001 + 1000 \log_e 1.001 \\ &= 6.909 + 0.999 = 7.908. \end{aligned}$$

The self inductance of the short wire AB, suppose 1 cm long and of 1 mm radius, is

$$\dot{L}_1 = 2 \left( \log \frac{2}{0.1} - .75 \right) = 2(2.9957 - .75) = 4.4915 \text{ cm},$$

which is a little more than one-half of the mutual inductance of AB and BC, BC being 1000 times the length of AB.

In closed circuits, all the magnetic lines due to a circuit are effective in producing self-inductance, and hence the self-inductance is always greater than the mutual inductance of that circuit with any other, assuming one turn in each. But with open circuits, as in this case, we may have a mutual inductance between two conductors *greater* than the self-inductance of one of them.

#### SECOND DERIVATION OF FORMULA (17).

We may derive formula (17) for the mutual inductance of two linear conductors forming parts of the same straight line by use of formula (10). Let  $L_l$  be the self-inductance of AB,  $L_m$  of BC, and  $L$  that of the whole line ABC. Then we have by (10)

$$\begin{aligned} L_l &= 2l \left( \log \frac{2l}{\rho} - \frac{3}{4} \right) \\ L_m &= 2m \left( \log \frac{2m}{\rho} - \frac{3}{4} \right) \\ L &= 2(l+m) \left[ \log \frac{2(l+m)}{\rho} - \frac{3}{4} \right] \end{aligned} \quad (19)$$

The mutual inductance  $M_{lm}$  of the two straight lines AB and BC is then given by the expression

$$L = L_l + L_m + 2M_{lm}$$

From above  $L_l + L_m = 2(l+m) \left[ \log \frac{2(l+m)}{\rho} - \frac{3}{4} \right] - 2l \log \frac{m}{l}$

$$\therefore 2M_{lm} = 2(l+m) \left[ \log \frac{l+m}{m} \right] + 2l \log \frac{m}{l}$$

or  $M_{lm} = l \log \frac{l+m}{l} + m \log \frac{l+m}{m}$

which is equation (17), found independently above by integrating over the area  $S_2$  the magnetic flux due to unit current in AB.

6. DEFINITION OF SELF-INDUCTANCE OF AN OPEN CIRCUIT.

It is of course impossible to maintain a steady current in a finite straight conductor, or even to start a current in such a conductor without having a return in the form of a displacement current. One can excite an oscillatory current in such a conductor, but the displacement current which closes the circuit will produce magnetic force at a distance, and hence the actual self-inductance of such a circuit is not the value of the self-inductance given by equation (9).

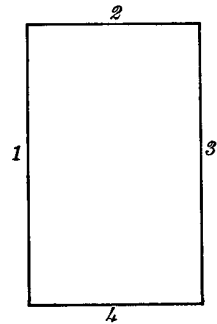

Fig. 6.

The latter is the self-inductance of a part of a closed circuit due to the current in itself. The actual self-inductance of any closed circuit of which it is a part will be the sum of the self-inductances of all the parts, plus the sum of the mutual inductances of each one of the component parts on all the other parts. Thus the self-inductance of a rectangle is the sum of the self-inductances of the four sides (by equation 10) plus the sum of the mutual inductances

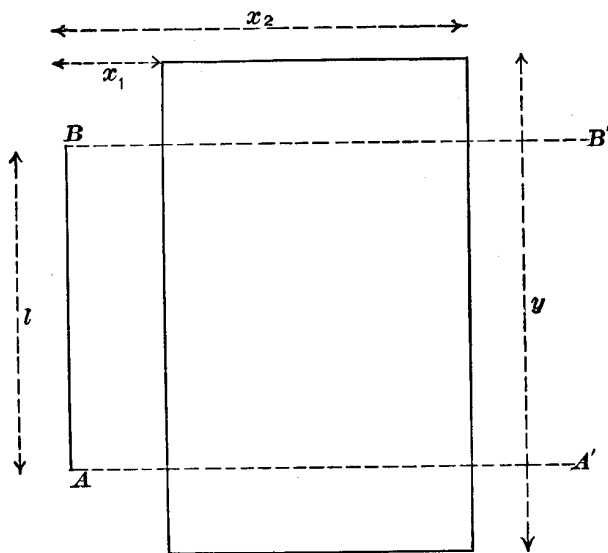

Fig. 7.

of 1 and 3 on each other, and of 2 and 4 on each other (taking account of sign the mutual inductances will be negative). Since the lines of force due to side 1 in collapsing do not cut 2 and 4, the mutual inductance of 1 and 3 on 2 and 4 is zero.

In a recent number of the *Elektrotechnische Zeitschrift*,<sup>4</sup> Wagner shows that the total magnetic

flux of a finite straight conductor as derived from the Biot-Savart law has an infinite value, and concludes that the self-inductance is therefore infinite and hence that one can properly

<sup>4</sup>Karl Willy Wagner, *Elek. Zeit.*, July 4, 1907, p. 673.

speak of the self-inductance only for closed circuits. In reaching this conclusion he takes the integral expression given by Sumec<sup>5</sup> for the flux through a rectangle of length  $y$  and breadth  $x_2 - x_1$  due to a finite straight wire of length  $l$ , as shown in Fig. 7. He then lets the rectangle expand,  $x_1$  being constant, and the ratio  $y/x_2$  remaining constant until  $x_2$  and  $y$  are both infinite. This gives an infinite value to the flux, but does not prove the self-inductance of the finite wire AB to be infinite, defining the self-inductance as I have done above. When the current in the wire decreases, the field everywhere decreases in intensity, and we think of the lines as collapsing upon the wire; that is, moving in from all sides upon the wire. But those lines above BB' and below AA' do not cut the wire, and hence contribute nothing to the self-inductance. For no lines of force cut across the lines BB' and AA' (BB' and AA' of course extend to infinity) as the field becomes weaker; the lines above BB' and below AA' collapse upon the axis extended of the wire AB.

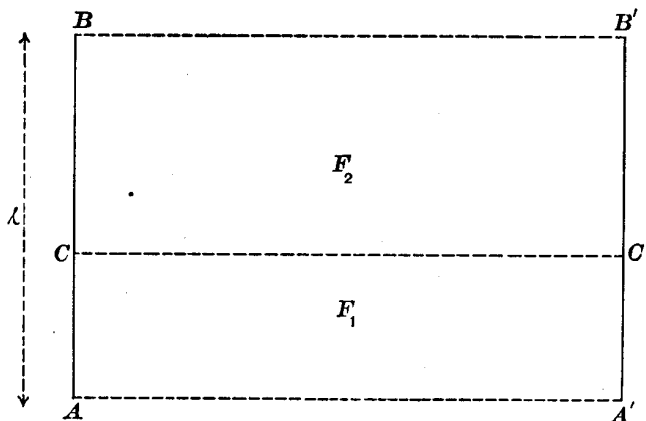

Fig. 8.

Looking at it in another way, suppose the wire is divided into two parts at C, and the field between BB' and AA' is divided into F<sub>1</sub> and F<sub>2</sub>. The lines of force in F<sub>1</sub> are due to the whole wire AB and not to AC simply, but in collapsing when the current ceases they cut only AC. So the lines in F<sub>2</sub> are due to the whole wire AB, but they cut only CB. Therefore in getting an expression for the self-inductance of the wire AB we must find the number of lines of

<sup>5</sup>J. K. Sumec, Elek. Zeit.; Dec. 20, 1906, p. 1175.

force included between  $BB'$  and  $AA'$  integrating to infinity, and this is a finite number, as shown above, (3) or (4).

To repeat what has already been said above, the self-inductance of a finite straight wire means its self-inductance as a part of some closed circuit. The infinite field at a distance due to it is canceled by that due to the other parts of the closed circuit which are not specified. We take account only of those lines which cut the given conductor in calculating its own self-inductance, and of those lines only which cut other parts of the circuit in calculating mutual inductances, ignoring the lines which do neither.

In the case of an oscillating current in a finite straight wire, at the moment when the current  $i$  is a maximum and the potential of the wire is sensibly uniform and equal to zero the energy is  $\frac{1}{2}Li^2$ , where  $L$  is the self-inductance and  $i$  is the current at the instant.

The value of  $L$  is not the value given by (9) nor yet the infinite value found by Wagner, but is a finite value due to the finite conductor taken in connection with the return displacement circuit. It is indeed the self-inductance of a closed circuit, and not simply of the conductor in question. This I take it is what Wagner means, and not that we can not speak of the self-inductance of an unclosed circuit in the sense in which it is done throughout this article.

#### 7. THE SELF-INDUCTANCE OF A STRAIGHT RECTANGULAR BAR.

The self-inductance of a straight bar of rectangular section is, to within the accuracy of the approximate formula (13), the same as the mutual inductance of two parallel straight filaments of the same length separated by a distance equal to the geometrical mean distance of the cross section of the bar. Thus,

$$L = 2l \left[ \log \frac{2l}{R} - 1 + \frac{R}{l} \right] \quad (20)$$

where  $R$  is the geometric mean distance of the cross section of the rod or bar. If the section is a square,  $R = .447 a$ ,  $a$  being the side of the square. If the section is a rectangle, the value of  $R$  is given by Maxwell's formula. (E. and M., § 692.) For example, when the rectangular section is  $4 \times 1$  cm,  $R = 1.118$  cm. Thus the self-

inductance of a straight square rod is a little less than that of a round rod of the same diameter, equal indeed to the self-inductance of a round rod of diameter 1.15 times the side of the square.

Sumec has called attention to the fact that the geometrical mean distance for the area of a rectangle is very nearly proportional to the length of the two sides of the rectangle. Putting  $a$  and  $\beta$  for the lengths of the two sides of the rectangle, and  $R$  for the geometrical mean distance of the rectangle from itself,

$$R = 0.2235(a + \beta) \text{ nearly for all values of } a \text{ and } \beta.$$

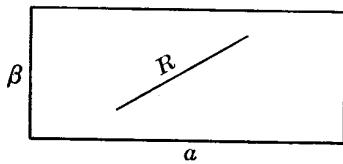

Fig. 9.

The following table shows how nearly constant is the ratio  $\frac{R}{a + \beta}$  for rectangles of different proportions:

TABLE I.

$a$  and  $\beta$  are the Length and Breadth of the Rectangles.  $R$  is the Geometrical Mean Distance of its Area.

Ratio	$R$	$\frac{R}{a + \beta}$
1 : 1	0.44705a	0.22353
1.25 : 1	0.40235a	0.22353
1.5 : 1	0.37258a	0.22355
2 : 1	0.33540a	0.22360
4 : 1	0.27961a	0.22369
10 : 1	0.24596a	0.22360
20 : 1	0.23463a	0.22346
1 : 0	0.22315a	0.22315

The simple relation between the g. m. d. of a rectangle and the sum of its two sides,  $a + \beta$ , is rather remarkable and, in view of the complicated formula employed in calculating  $R$  for a rectangle, very fortunate. Substituting this value of  $R$  in formula (20) we

have, since  $\log_e \frac{1}{0.2235} = 1.500$  nearly,

$$L = 2l \left[ \log \frac{2l}{a+\beta} + \frac{1}{2} + \frac{0.2235(a+\beta)}{l} \right] \tag{21}$$

as the formula for the self-inductance of a straight bar or wire of length  $l$  and having a rectangular section of length  $a$  and breadth  $\beta$ . Substituting  $l=1000$ , and  $a+\beta=2$  for a square bar 1000 cm long and 1 square cm section we have, neglecting the small last term,

$$\begin{aligned} L &= 2000 \left[ \log_e \frac{2000}{2} + \frac{1}{2} \right] \\ &= 2000 (6.908 + 0.5) = 14816 \text{ cm} \\ &= 14.816 \text{ microhenrys.} \end{aligned}$$

This would also be the self-inductance for any section having  $a+\beta = 2$  cm.

For a rectangular bar of section  $1 \times 4$  cm, we have similarly

$$\begin{aligned} L &= 2000 \left[ \log_e \frac{2000}{5} + \frac{1}{2} \right] \\ &= 12.983 \text{ microhenrys.} \end{aligned}$$

For a wire of rectangular section  $1 \times 4$  mm, and 10 meters long

$$L = 17.588 \text{ microhenrys.}$$

**8. TWO PARALLEL BARS.—SELF AND MUTUAL INDUCTANCE.**

The mutual inductance of two parallel straight, square, or rectangular bars is equal to the mutual inductance of two parallel wires

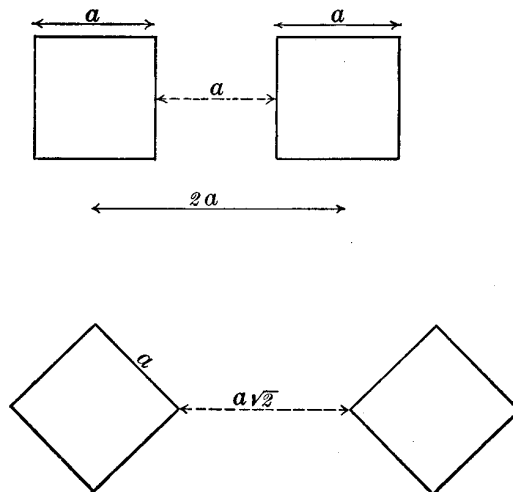

Fig. 10.

or filaments of the same length and at a distance apart equal to the geometrical mean distance of the two areas from one another. This is very nearly equal in the case of square sections to the distance between their centers for all distances, the g. m. d. being a very little greater for parallel squares, and a very little less for diagonal squares<sup>6</sup> (Fig. 10). We should, therefore, use equation (13) with  $d$  equal to the g. m. d. of the sections from one another; that is, substantially, to the distances between the centers. For the two parallel square rods 10 meters long and 1 cm square (Fig. 10) we have therefore for the mutual inductance using (13), and taking  $R = 2.0$  cm,<sup>7</sup>

$$\begin{aligned} M &= 2000 \left( \log_e \frac{2000}{2} - 1 \right) \\ &= 2000 (6.9077 - 1) \\ &= 11.815 \text{ microhenrys.} \end{aligned}$$

The self-inductance of a return circuit of two such parallel bars is equal to twice the self-inductance of one minus twice their mutual inductance. That is,

$$\begin{aligned} L &= 2(L_1 - M) \\ &= 2(14.812 - 11.815) \\ &= 5.994 \text{ microhenrys.} \end{aligned}$$

If they were adjacent to one another the self-inductance of the two bars would be (their mutual inductance in that case being 13.190)

$$\begin{aligned} L &= 2(14.812 - 13.190) \\ &= 3.244 \text{ microhenrys.} \end{aligned}$$

These calculations are of course all based on the assumption of a uniform distribution of current through the cross section of the conductors. For alternating currents in which the current density is greater near the surface the self-inductance is less but the mutual inductance is substantially unchanged.

<sup>6</sup> Rosa, this Bulletin, 3, p. 1.

<sup>7</sup> Its more exact value is 2.0010, this Bulletin, 3, p. 9.



9. SELF-INDUCTANCE OF A SQUARE.

The self-inductance of a square may be derived from the expression for the self and mutual inductance of finite straight wires from the consideration that the self-inductance of the square is the sum of the self-inductances of the four sides minus the mutual inductances. That is,

$$L = 4L_1 - 4M$$

the mutual inductance of two mutually perpendicular sides being zero. Substituting  $a$  for  $l$  and  $d$  in formulæ (9) and (12) we have

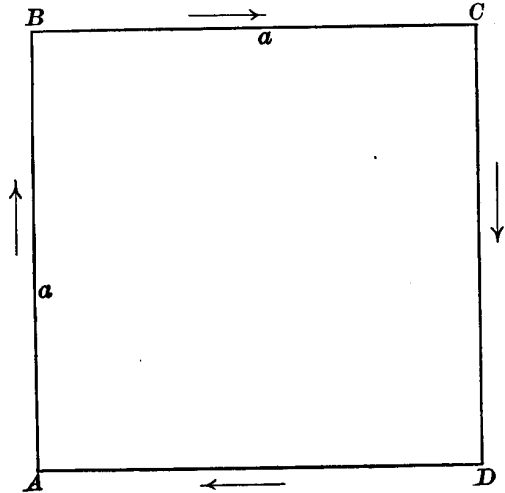

Fig. 11.

$$L_1 = 2a \left[ \log \frac{a + \sqrt{a^2 + \rho^2}}{\rho} - \sqrt{1 + \frac{\rho^2}{a^2}} + \frac{1}{4} + \frac{\rho}{a} \right]$$

$$M = 2a \left[ \log \frac{a + \sqrt{2}a}{a} - \sqrt{2} + 1 \right]$$

Neglecting  $\rho^2/a^2$ ,

$$L_1 - M = 2a \left[ \log \frac{2a}{\rho(1 + \sqrt{2})} - 1.75 + \sqrt{2} + \frac{\rho}{a} \right]$$

$$\therefore L = 4(L_1 - M) = 8a \left[ \log \frac{a}{\rho} - \log \frac{1 + \sqrt{2}}{2} + \frac{\rho}{a} - 0.3358 \right] \quad (22)$$

$$\text{or } L = 8a \left( \log \frac{a}{\rho} + \frac{\rho}{a} - 0.524 \right) \quad (22a)$$

where  $a$  is the length of one side of the square and  $\rho$  is the radius of the wire. If we put  $l = 4a =$  whole length of wire in the square,

$$L = 2l \left( \log \frac{l}{\rho} + \frac{4\rho}{l} - 1.910 \right)$$

$$\text{or, } L = 2l \left( \log \frac{l}{\rho} - 1.910 \right), \text{ approximately.} \quad (23)$$

Formulae (22) and (23) were first given by Kirchhoff<sup>8</sup> in 1864.

If  $a = 100$  cm,  $\rho = 0.1$  cm, we have from (22)

$$\begin{aligned} L &= 800 (\log_e 1000 - 0.524) \\ &= 5107 \text{ cm} = 5.107 \text{ microhenrys.} \end{aligned}$$

If  $\rho = .05$  cm,

$$L = 5662 \text{ cm} = 5.662 \text{ microhenrys.}$$

That is, the self inductance of such a rectangle of round wire is about 11 per cent greater for a wire 1 mm in diameter than for one 2 mm in diameter.

If  $l/\rho$  is constant,  $L$  is proportional to  $l$ .

That is, if the thickness of the wire is proportional to the length of the wire in the square, the self-inductance of the square is proportional to its linear dimensions.

If in the above case where  $\rho = 0.1$ ,  $a = 200$  cm,

$$L = 1600 (\log_e 2000 - 0.524) = 2 \times 5.662 \text{ microhenrys.}$$

That is, for a square 200 cm on a side,  $L$  is 11 per cent more than double its value for a square of 100 cm. on a side.

#### 10. SELF-INDUCTANCE OF A RECTANGLE.

(a) *The conductor having a circular section.*

The self-inductance of the rectangle of length  $a$  and breadth  $b$  is

$$L = 2 (L_a + L_b - M_a - M_b)$$

where  $L_a$  and  $L_b$  are the self-inductances of the two sides of length  $a$  and  $b$  taken alone,  $M_a$  and  $M_b$  are the mutual inductances of the two opposite pairs of length  $a$  and  $b$ , respectively.

---

<sup>8</sup> Gesammelte Abhandlungen, p. 176. Pogg. Annal. 121, 1864.

From (9) and (12) we therefore have, neglecting  $\rho^2/a^2$ ,

$$L = 4 \left[ a \log \frac{2a}{\rho} - \frac{3}{4}a + \rho \right] + 4 \left[ b \log \frac{2b}{\rho} - \frac{3}{4}b + \rho \right] \\ - 4 \left[ a \log \frac{a + \sqrt{a^2 + b^2}}{b} - \sqrt{a^2 + b^2} + b \right] \\ - 4 \left[ b \log \frac{b + \sqrt{a^2 + b^2}}{a} - \sqrt{a^2 + b^2} + a \right]$$

Putting  $\sqrt{a^2 + b^2} = d$ , the diagonal of the rectangle,

$$L = 4 \left[ a \log \frac{2ab}{\rho(a+d)} + d - \frac{3a}{4} - b + \rho \right] \\ + 4 \left[ b \log \frac{2ab}{\rho(b+d)} + d - \frac{3b}{4} - a + \rho \right]$$

or

$$L = 4 \left[ (a+b) \log \frac{2ab}{\rho} - a \log(a+d) - b \log(b+d) \right. \\ \left. - \frac{7}{4}(a+b) + 2(d+\rho) \right] \quad (24)$$

For  $a = 200$  cm,  $b = 100$ ,  $\rho = 0.1$

$$L = 8017.1 \text{ cm} = 8.017 \text{ microhenrys.}$$

(b) *The conductor having a rectangular section.*

For a rectangle made up of a conductor of rectangular section,  $a \times \beta$ ,

$$L_a = 2 \left[ a \log \frac{2a}{a+\beta} + \frac{a}{2} + 0.2235(a+\beta) \right]$$

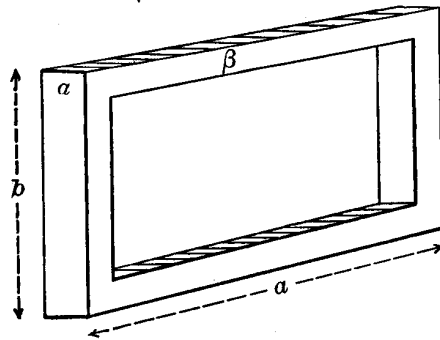

Fig. 12.

$$M_a = 2 \left[ a \log \frac{a + \sqrt{a^2 + b^2}}{b} - \sqrt{a^2 + b^2} + b \right]$$

and  $L = 2 (L_a + L_b - M_a - M_b)$ , as before.

$$\begin{aligned} \therefore L = & 4 \left[ a \log \frac{2ab}{(a+\beta)(a+\sqrt{a^2+b^2})} + \frac{a}{2} - b + \sqrt{a^2+b^2} \right. \\ & \left. + 0.2235 (a+\beta)_a \right] \\ & + 4 \left[ b \log \frac{2ab}{(a+\beta)(b+\sqrt{a^2+b^2})} + \frac{b}{2} - a + \sqrt{a^2+b^2} \right. \\ & \left. + 0.2235 (a+\beta)_b \right] \end{aligned}$$

Putting as before  $d = \sqrt{a^2 + b^2}$  = diagonal of the rectangle, and assuming that the section of the rectangle is uniform; that is, that  $(a+\beta)_a = (a+\beta)_b$ ,

$$\begin{aligned} L = & 4 \left[ (a+b) \log \frac{2ab}{a+\beta} - a \log (a+d) - b \log (b+d) \right. \\ & \left. - \frac{a+b}{2} + 2d + 0.447 (a+\beta) \right] \end{aligned} \quad (25)$$

This is equivalent to Sumec's exact formula<sup>9</sup> (6a), the logarithm of course being natural in (25), as elsewhere in this article.

For  $a = b$ , a square,

$$\begin{aligned} L = & 8a \left[ \log \frac{2a^2}{a+\beta} - \frac{1}{2} + \frac{d}{a} - \log (a+a\sqrt{2}) + 0.2235 \frac{(a+\beta)}{a} \right] \\ = & 8a \left[ \log \frac{a}{a+\beta} + 0.2235 \frac{a+\beta}{a} + 0.726 \right] \end{aligned}$$

If  $a = \beta$ ,

$$L = 8a \left[ \log \frac{a}{a} + .447 \frac{a}{a} + .033 \right] \quad (25a)$$

If  $a = 1000$ ,  $a = 1$ ,

$$\begin{aligned} L = & 8000 [6.908 + .033] \\ = & 8000 \times 6.941 \text{ cm} = 55.53 \text{ microhenrys.} \end{aligned}$$

<sup>9</sup> Elek. Zeit., p. 1175, 1906.

For a circular section, of diameter 1 cm,  $\rho=0.5$

$$L = 8000 \left( \log_e 2000 + \frac{1}{2000} - .524 \right)$$

$$= 8000 \times 7.076 \text{ cm} = 56.61 \text{ microhenrys,}$$

a little *more* than for a square section, as would be expected.

### 11. MUTUAL INDUCTANCE OF TWO EQUAL PARALLEL RECTANGLES.

For two equal parallel rectangles of sides  $a$  and  $b$  and distance apart  $d$  the mutual inductance is the sum of the several mutual inductances of parallel sides. Writing  $M_{15}$  for the mutual inductance of side 1 on 5, etc., we have

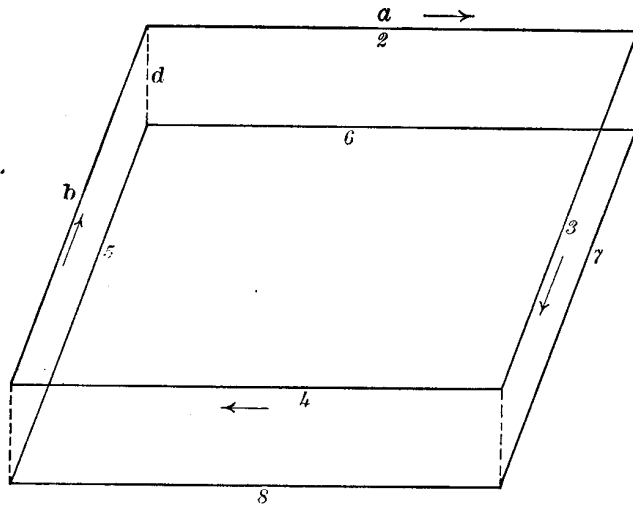

Fig. 13.

$$M = 2 (M_{15} - M_{17}) + 2(M_{26} - M_{28})$$

$$\text{From (12)} \quad M_{15} = 2 \left[ b \log \frac{b + \sqrt{b^2 + d^2}}{d} - \sqrt{b^2 + d^2} + d \right]$$

$$M_{17} = 2 \left[ b \log \frac{b + \sqrt{a^2 + b^2 + d^2}}{\sqrt{a^2 + d^2}} - \sqrt{a^2 + b^2 + d^2} + \sqrt{a^2 + d^2} \right]$$

$$M_{26} = 2 \left[ a \log \frac{a + \sqrt{a^2 + d^2}}{d} - \sqrt{a^2 + d^2} + d \right]$$

$$M_{28} = 2 \left[ a \log \frac{a + \sqrt{a^2 + b^2 + d^2}}{\sqrt{b^2 + d^2}} - \sqrt{a^2 + b^2 + d^2} + \sqrt{b^2 + d^2} \right]$$

$$\begin{aligned} \therefore M = 4 & \left[ a \log \left( \frac{a + \sqrt{a^2 + d^2}}{a + \sqrt{a^2 + b^2 + d^2}} \cdot \frac{\sqrt{b^2 + d^2}}{d} \right) \right. \\ & \left. + b \log \left( \frac{b + \sqrt{b^2 + d^2}}{b + \sqrt{a^2 + b^2 + d^2}} \cdot \frac{\sqrt{a^2 + d^2}}{d} \right) \right] \\ & + 8 \left[ \sqrt{a^2 + b^2 + d^2} - \sqrt{a^2 + d^2} - \sqrt{b^2 + d^2} + d \right] \end{aligned} \quad (26)$$

For a square, where  $a = b$ , we have

$$\begin{aligned} M = 8 & \left[ a \log \left( \frac{a + \sqrt{a^2 + d^2}}{a + \sqrt{2a^2 + d^2}} \cdot \frac{\sqrt{a^2 + d^2}}{d} \right) \right] \\ & + 8 \left[ \sqrt{2a^2 + d^2} - 2\sqrt{a^2 + d^2} + d \right] \end{aligned} \quad (27)$$

These two formulæ (26) and (27) may also be derived by integrating Neumann's formula around the rectangles.<sup>10</sup>

Formula (26) was first given by F. E. Neumann<sup>11</sup> in 1845.

12. SELF AND MUTUAL INDUCTANCE OF THIN TAPES.

The self-inductance of a straight thin tape of length  $l$  and breadth  $b$  (and of negligible thickness) is equal to the mutual inductance of two parallel lines of distance apart  $R_1$  equal to the geometrical mean distance of the section, which is  $0.22313 b$ ,

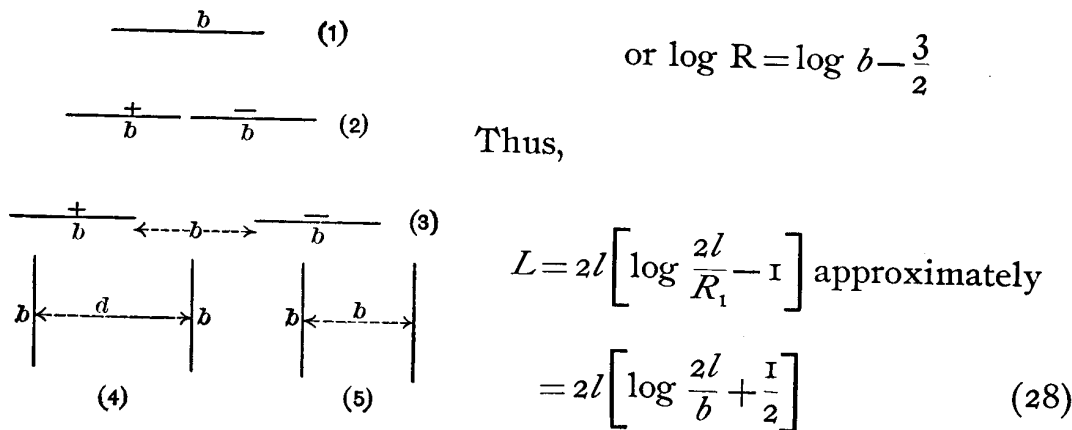

Fig. 14.

For two such tapes in the same plane, coming together at their edges

<sup>10</sup> Webster, Electricity and Magnetism, p. 456. Wallentin, Theoretische Elektrizitätslehre, p. 344. Fleming, ———.

<sup>11</sup> Allgemeine Gesetze der Inducirten Ströme, Abh. Berlin Akad.

without making electrical contact, the mutual inductance is

$$\begin{aligned} M &= 2l \left[ \log \frac{2l}{R_2} - 1 \right] \\ &= 2l \left[ \log \frac{2l}{b} - 0.8863 \right] \end{aligned} \quad (29)$$

where  $R_2$  is the geometrical mean distance of one tape from the other, which in this case is  $0.89252 b$ . For a return circuit made up of these two tapes the self-inductance is

$$\begin{aligned} L &= 2L_1 - 2M \\ &= 4l \left( \log \frac{R_2}{R_1} \right) = 4l \log_e 4 \\ &= 5.545 \times \text{length of one tape.} \end{aligned} \quad (30)$$

Thus the self-inductance of such a circuit is independent of the width of the tapes. If the tapes are separated by the distance  $b$ ,  $R_2 = 1.95653 b$  and  $L = 8.685 l$ .

If the two tapes are not in the same plane but parallel and at a distance apart  $d$  (4) Fig. 14, then the geometrical mean distance between the tapes is given by the formula.

$$\log R = \frac{d^2}{b^2} \log d + \frac{1}{2} \left( 1 - \frac{d^2}{b^2} \right) \log (b^2 + d^2) + 2 \frac{d}{b} \tan^{-1} \frac{b}{d} - \frac{3}{2} \quad (31)$$

If  $d = b$ , (5) Fig. 9,

$$\log R_2 = \log b + \frac{\pi}{2} - \frac{3}{2} \quad (32)$$

For a single tape

$$\log R_1 = \log b - \frac{3}{2} \quad (33)$$

Hence  $\log \frac{R_2}{R_1} = \frac{\pi}{2}$  and for the case shown at (5) Fig. 14,

$$\begin{aligned} L &= 2L_1 - 2M = 4l \log \frac{R_2}{R_1} \\ &= 4l \frac{\pi}{2} = 2\pi l \end{aligned} \quad (34)$$

In this case also the self-inductance of  $2\pi$  cm per unit of length of the pair of thin strips is independent of their width so long as the distance apart is equal to their width. The self-inductance is as much greater in this case than in the case shown in (2) Fig. 14, as  $\frac{\pi}{2}$  is greater than  $\log_e 4$ , or 1.13 times.

### 13. CASE OF TWO PARALLEL PLATES.—NONINDUCTIVE SHUNTS.

If a thin sheet of manganin or other conductor is doubled on itself to form a noninductive shunt we can calculate approximately its self-inductance by the above method.

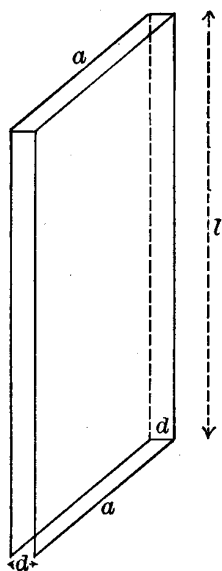

Fig. 15.

$$\text{Let } l = 30 \text{ cm}$$

$$a = 10 \text{ cm}$$

$$d = 1 \text{ cm}$$

By (31)

$$\log R_2 = 1.0787$$

$$\log R_1 = \log_e 10 - \frac{3}{2} = 0.8026$$

$$L = 4l (\log R_2 - \log R_1) = 120 \times 0.2761$$

$$= 33.13 \text{ cm}$$

$$= .0331 \text{ microhenrys.}$$

If the resistance of the shunt is .001 ohm, and the frequency of the current through it is 100 cycles

$$p \frac{L}{R} = \tan \phi = .02$$

and  $\phi$ , the angle of lag of the current in the shunt behind the emf. at the terminals is approximately  $1^\circ$ . If  $n = 1000$ ,  $\phi = 12^\circ$  nearly. By bringing the two halves of the sheet nearer together  $\phi$  could of course be reduced considerably below  $1^\circ$  for 100 cycles. This would be desirable for high frequencies. If the sheet were used straight in the above example the inductance would be six times as great, unless a return conductor were near.



14. USE OF THE GEOMETRIC MEAN DISTANCE.

In the approximate formula for the mutual inductance of two parallel wires

$$M = 2l \left[ \log \frac{2l}{d} - 1 \right]$$

we have only one variable,  $d$ . In applying this to determine the self-inductance of a thin, straight strip we make use of the theorem that the self-inductance of a circuit is equal to the sum of all the mutual inductances of the component parts of the circuit; that is, the sum of the inductances of every element upon itself and every other element. If there are  $n$  elements each carrying  $\frac{I}{n}$ -th of the

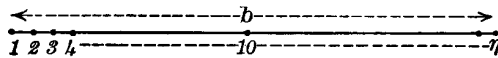

Fig. 16.

current, each of these  $n^2$  component inductances will be multiplied by  $\frac{I}{n^2}$ , if the total current is unity. Hence we see that the value of the self-inductance is the average value of the  $n^2$  separate mutual inductances. But each mutual inductance is

$$M = 2l(\log 2l - \log d - 1) \tag{35}$$

and as the first and third terms are constant, we have only to find the average value of  $\log d$ , where  $d$  is the distance between every pair of points in the straight line of length  $b$  which is the section of the strip. Since

$$\begin{aligned} \frac{I}{n} \left[ \log d_1 + \log d_2 + \dots + \log d_n \right] &= \frac{I}{n} \log \left[ d_1 d_2 d_3 \dots d_n \right] \\ &= \log \sqrt[n]{d_1 d_2 d_3 \dots d_n} \\ &= \log R \end{aligned}$$

we see that what Maxwell called the geometrical mean distance  $R$  of the line is the  $n^{\text{th}}$  root of the product of the  $n$  distances between all the various pairs of points in the line,  $n$  being increased to infinity in determining the value of  $R$ . This shows why the term *geometrical mean distance* was chosen.

The more exact formula (12) for the mutual inductance of two straight parallel lines may be written

$$M = 2[l \log (l + \sqrt{l^2 + d^2}) - l \log d - \sqrt{l^2 + d^2} + d] \quad (36)$$

In getting the mean value of this expression for  $n$  pairs of points along the line  $b$  we must find not only the mean value of  $\log d$ , but also the mean value of  $d$  itself and of  $d^2$ . The latter means will not be the same as the geometrical mean distance  $R$ , but are the *arithmetical mean distance* and the *arithmetical mean square distance*. In order, therefore, to obtain an accurate value of the self-inductance  $L$  for the strip we should determine these arithmetical mean distances for the section of the strip.

#### 15. DETERMINATION OF THE ARITHMETICAL MEAN DISTANCES OF A LINE.

Let  $AB$  be the line of length  $b$ , and we first find the arithmetical mean distance  $S_1$  of the point  $P$  ( $AP = c$ ) from all the points of the line.

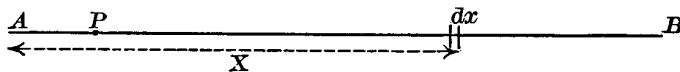

Fig. 17.

This may be done by integration, but the a. m. d. from  $P$  to all points in the line to the right of  $P$  is, obviously,  $\frac{b-c}{2}$ , and to the left  $\frac{c}{2}$ . Hence for the whole line

$$\begin{aligned} bS_1 &= \frac{b-c}{2}(b-c) + \frac{c}{2}c = \frac{(b-c)^2}{2} + \frac{c^2}{2} \\ \therefore S_1 &= \frac{b}{2} - c + \frac{c^2}{b} \end{aligned} \quad (37)$$

To find  $S_2$ , the a. m. d. of all points of the line from the line, or the a. m. d. of the line from itself we must integrate  $S_1$  over the line. Thus, putting  $c = x$ ,

$$\begin{aligned} bS_2 &= \int_0^b \left( \frac{b}{2} - x + \frac{x^2}{b} \right) dx = \left[ \frac{bx}{2} - \frac{x^2}{2} + \frac{x^3}{3b} \right]_0^b \\ &= \frac{b^2}{3} \\ \therefore S_2 &= \frac{b}{3} \end{aligned} \quad (38)$$

Thus while the geometrical mean distance of a line is 0.22313 times its length the arithmetical mean distance is one-third the length.

To find the arithmetical mean square distance  $S_1^2$  from the point P to the line we integrate as follows :

$$bS_1^2 = \int_0^b (x-c)^2 dx = \frac{b^3}{3} - cb^2 + c^2b$$

$$\therefore S_1^2 = \frac{b^2}{3} - cb + c^2 \quad (39)$$

$$\text{If } c=0, S_1^2 = \frac{b^2}{3}$$

That is, the arithmetical mean square distance from one end of a line to the line is  $b^2/3$ . Also

$$\sqrt{S_1^2} = \frac{b}{\sqrt{3}}$$

To find the a. m. s. d.  $S_2^2$  we integrate again, changing  $c$  to  $x$ ,

$$bS_2^2 = \int_0^b \left( \frac{b^2}{3} - bx + x^2 \right) dx = \frac{b^3}{6}$$

$$\therefore S_2^2 = \frac{b^2}{6}, \sqrt{S_2^2} = \frac{b}{\sqrt{6}} \quad (40)$$

If now in formula (36) above we make the proper substitutions of geometrical and arithmetical mean distances, we shall obtain a more accurate expression for the self-inductance of a thin strip. Since  $d$  is small compared with  $l$ , formula (36) is very nearly equal to

$$L = 2 \left[ l \log \left( 2l \left[ 1 + \frac{d^2}{4l^2} \right] \right) - l \log d - l - \frac{d^2}{2l} + d \right] \quad (41)$$

$$= 2l \left[ \log 2l - \log d - 1 - \frac{d^2}{4l^2} + \frac{d}{l} \right]$$

For  $\log d$  put  $\log b - \frac{3}{2}$

“  $d^2$  put  $b^2/6$

“  $d$  put  $b/3$

Then

$$L = 2l \left[ \log \frac{2l}{b} + \frac{1}{2} + \frac{b}{3l} - \frac{b^2}{24l^2} \right] \quad (42)$$

which is the self-inductance of a straight thin strip of length  $l$  and breadth  $b$ .

This formula neglects only terms in  $b^4/l^4$ , and is therefore quite accurate. The value previously found (equation 28) is the same except for the last two terms. Formula (28) is of course accurate enough for most cases; but it is interesting to see what the more accurate expression is when we make use of the arithmetical mean distances in getting the values of the terms neglected in the first approximation.

#### 16. SELF-INDUCTANCE OF A CIRCLE OF THIN STRIP.

Let us apply the principle of geometrical and arithmetical mean distances to obtain the self-inductance of a circular band of radius  $a$  and width  $b$ . This is a short cylindrical current sheet, for which we have the formula of Rayleigh:

$$L = 4\pi a \left[ \log \frac{8a}{b} - \frac{1}{2} + \frac{b^2}{32a^2} \left( \log \frac{8a}{b} + \frac{1}{4} \right) \right] \quad (43)$$

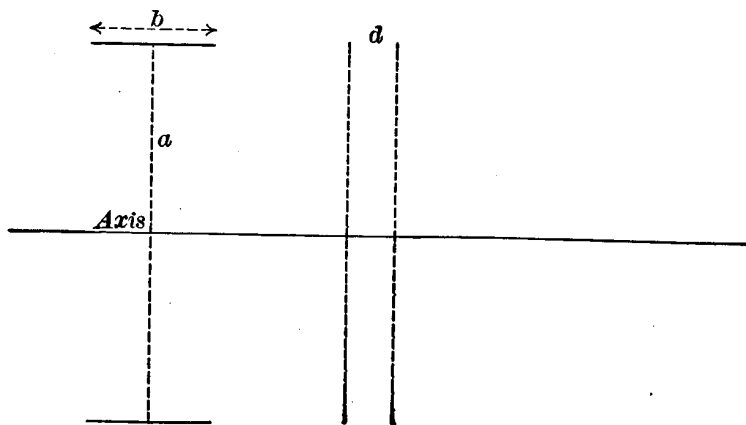

Fig. 18.

Coffin's formula gives some additional terms in  $b^4/l^4$  and higher powers, but when  $b$  is not more than one-fourth of  $a$ , Rayleigh's formula is correct to within about one part in 100,000, and may therefore serve as a check on the method of geometrical and arithmetical mean distances. The mutual inductance of two parallel

circles of radius  $a$  and distance apart  $d$  is, neglecting terms in  $d^4/a^4$  and higher powers,

$$M = 4\pi a \left[ \left( 1 + \frac{3d^2}{16a^2} \right) \log \frac{8a}{d} - \left( 2 + \frac{d^2}{16a^2} \right) \right] \quad (44)$$

which may be written

$$M = 4\pi a \left[ \left( 1 + \frac{3d^2}{16a^2} \right) \log 8a - \log d - \frac{3d^2}{16a^2} \log d - 2 - \frac{d^2}{16a^2} \right] \quad (45)$$

In addition to the g. m. d. to be used in the second term and the arithmetical mean square distance in the first and last terms we have to know the mean value of a product of g. m. d. and a. m. s. d. in the third term; that is, a term of the form

$$S_2^2 \log R_2$$

To get this we must integrate as follows:

$$\begin{aligned} bS_1^2 \log R_1 &= \int_0^b (x-c)^2 \log(x-c) dx = \\ &= \frac{(b-c)^3}{3} \left[ \log(b-c) - \frac{1}{3} \right] + \frac{c^3}{3} \left[ \log c - \frac{1}{3} \right] \end{aligned} \quad (46)$$

$$\begin{aligned} b^2 S_2^2 \log R_2 &= \frac{1}{3} \int_0^b (b-x)^3 \log(b-x) dx + \frac{1}{3} \int_0^b x^3 \log x dx \\ &= -\frac{1}{9} \int_0^b (b-x)^3 dx - \frac{1}{9} \int_0^b x^3 dx \\ &= \frac{b^4}{6} \left( \log b - \frac{7}{12} \right) \end{aligned} \quad (47)$$

$$\therefore S_2^2 \log R_2 = \frac{b^2}{6} \left( \log b - \frac{7}{12} \right) \quad (48)$$

We may now substitute in (39) as follows:

$$\begin{aligned} \log d &= \log b - \frac{3}{2} \\ 3d^2 &= \frac{b^2}{2} \\ 3d^2 \log d &= \frac{b^2}{2} \left( \log b - \frac{7}{12} \right) \end{aligned}$$

This gives

$$L = 4\pi a \left[ \left( 1 + \frac{b^2}{32a^2} \right) \log 8a - \log b + \frac{3}{2} - \frac{b^2}{32a^2} \left( \log b - \frac{7}{12} \right) - 2 - \frac{b^2}{96a^2} \right]$$

$$= 4\pi a \left[ \left( 1 + \frac{b^2}{32a^2} \right) \log \frac{8a}{b} - \frac{1}{2} + \frac{b^2}{128a^2} \right] \tag{49}$$

which is Rayleigh's equation (43). This confirms the values of the quantities  $S_2^2$  and  $S_2^2 \log R_2$  employed in deducing the equation (49) from the formula (44) for M for two parallel circles.

17. ARITHMETICAL MEAN DISTANCES FOR A CIRCLE.

The arithmetical mean distance of any point P on the circumference of a circle from the circle is found by integrating around the circumference. Thus, since  $PB = 2a \cos \theta$

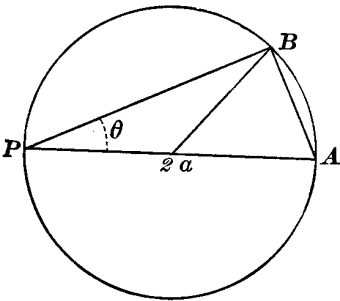

Fig. 19.

$$\pi a S_1 = \int_0^{\frac{\pi}{2}} 2a \cos \theta \cdot 2a d\theta = 4a^2$$

$$\therefore S_1 = \frac{4a}{\pi} \tag{50}$$

Since the a. m. d. is the same for every point of the circle we have also

$$S_2 = \frac{4a}{\pi} \tag{51}$$

For the arithmetical mean square distance we have

$$\pi a S_1^2 = \int_0^{\frac{\pi}{2}} 4a^2 \cos^2 \theta \cdot 2a d\theta = 2 \pi a^3$$

$$\left. \begin{aligned} \therefore S_1^2 = S_2^2 = 2a^2 \\ \text{and } \sqrt{S_2^2} = a\sqrt{2} \end{aligned} \right\} \tag{52}$$

That is, the square root of the arithmetical mean square distance of every point on a circumference of a circle from every other point is equal to the radius of the circle into the square root of 2.

For a point P outside or inside the circle we have, since

$$\overline{PB}^2 = a^2 + d^2 + 2ad \cos \theta$$

$$\pi a S_1^2 = a \int_0^\pi (a^2 + d^2 + 2ad \cos \theta) d\theta = \pi a (d^2 + a^2)$$

$$\therefore S_1^2 = d^2 + a^2 \tag{53}$$

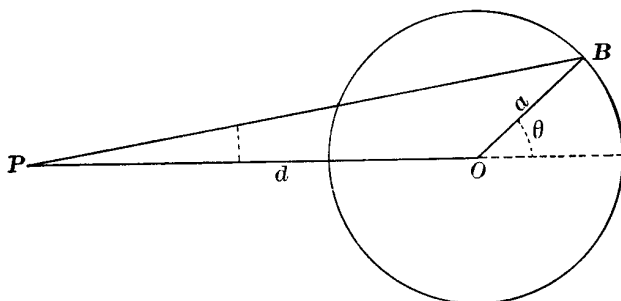

Fig. 20.

For the entire area of the circle with respect to the point P

$$\pi a^2 S_1^2 = \int_0^a (d^2 + r^2) 2\pi r dr = 2\pi \left[ \frac{a^3 d^2}{2} + \frac{a^4}{4} \right]$$

$$\therefore S_1^2 = d^2 + \frac{a^2}{2} \tag{54}$$

If  $d=0$ ,  $S_1^2 = \frac{a^2}{2}$ , the value for the area of the circle with respect to the center of the circle.

For the area of a circle with respect to itself, the a. m. s. d.,  $S_2^2$  would be found by integrating  $\overline{P_1 P_2}^2 = r_1^2 + r_2^2 - 2 r_1 r_2 \cos (\theta_2 - \theta_1)$  twice over the area of the circle.

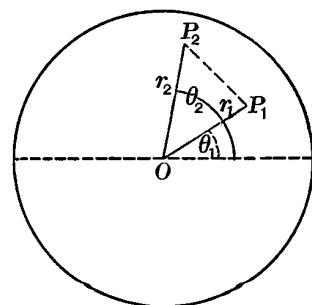

Fig. 21.

This was done in effect by Wien<sup>12</sup> in getting his formula for the self-inductance of a circle, which is a little more accurate than the formula deduced by the use of geometrical mean distances only, when the geometrical mean distances are used for the arithmetical mean distances.

These examples are sufficient to illustrate the differences in the values of the geometrical mean distances and the arithmetical mean

<sup>12</sup> M. Wien: Wied. Annal. 53, p. 928, 1894.

distances, and the use of the latter in the calculation of self and mutual inductances.

### 18. CONCENTRIC CONDUCTORS.

The self-inductance of a thin, straight tube of length  $l$  and radius  $a_2$  is, when  $a_2/l$  is very small,

$$L_2 = 2l \left[ \log \frac{2l}{a_2} - 1 \right] \quad (55)$$

The mutual inductance of such a tube on a conductor within it is equal to its self-inductance, since all the lines of force due to the outer tube cut through the inner when they collapse on the cessation of current. The self-inductance of the inner conductor, suppose a solid cylinder, is

$$L_1 = 2l \left[ \log \frac{2l}{a_1} - \frac{3}{4} \right]$$

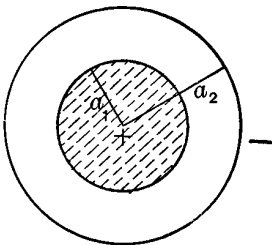

Fig. 22.

If the current goes through the latter and returns through the outer tube the self-inductance of the circuit is,

$$L = L_1 + L_2 - 2M = L_1 - L_2$$

since  $M$  equals  $L_2$

$$\therefore L = 2l \left[ \log \frac{a_2}{a_1} + \frac{1}{4} \right] \quad (56)$$

This result can also be obtained by integrating the expression for the force outside  $a_1$  between the limits  $a_1$  and  $a_2$ , and adding the term (equation 6) for the field within  $a_1$ , there being no magnetic field outside  $a_2$ . Thus

$$L = l \int_{a_1}^{a_2} \frac{2dr}{r} + \frac{l}{2} = 2l \left[ \log \frac{a_2}{a_1} + \frac{1}{4} \right] \text{ as above.}$$

If the outer tube has a thickness  $a_3 - a_2$  and the current is distributed uniformly over its cross section the self-inductance will be a



little greater, the geometrical mean distance from  $a_1$  to the tube, which is now more than  $a_2$  and less than  $a_3$ , being given by the expression

$$\log a_g = \frac{a_3^2 \log a_3 - a_2^2 \log a_2}{a_3^2 - a_2^2} - \frac{1}{2} \quad (57)$$

Putting this value of  $\log a$  in (56) in place of  $\log a$ , we should have the self-inductance of the return circuit of Fig. 23.

If the current is alternating and of very high frequency, the current would flow on the outer surface of  $a_1$  and on the inner surface of the tube, and  $L$  for the circuit would be

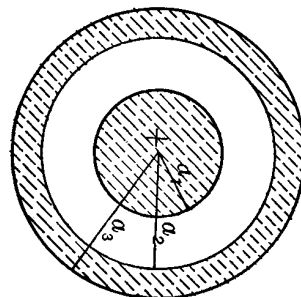

Fig. 23.

$$L = 2l \log \frac{a_2}{a_1} \quad (58)$$

19. MULTIPLE CONDUCTORS.

If a current be divided equally between two wires of length  $l$ , radius  $\rho$  and distance  $d$  apart, the self-inductance of the divided conductor is the sum of their separate self-inductances plus twice their mutual inductance.

Thus, when  $d/l$  is small,

$$L = 2 \left\{ \frac{l}{2} \left[ \log \frac{2l}{\rho} - \frac{3}{4} \right] + \frac{l}{2} \left[ \log \frac{2l}{d} - 1 \right] \right\}$$

$$\text{or } L = 2l \left[ \log \frac{2l}{(\rho d)^{\frac{1}{2}}} - \frac{7}{8} \right] = 2l \left[ \log \frac{2l}{(r_g d)^{\frac{1}{2}}} - 1 \right] \quad (59)$$

where  $r_g$  is the g. m. d. of the section of the wire =  $0.7788\rho$ .

If there are three straight conductors in parallel and distance  $d$  apart, as shown in Fig. 24, the self-inductance is similarly

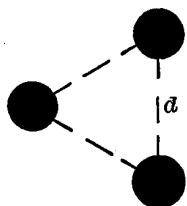
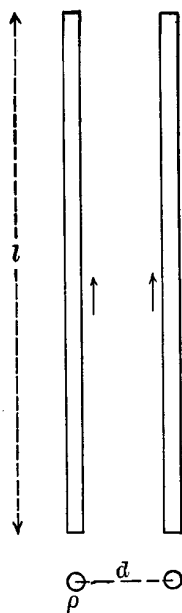

Fig. 24.

$$L = 2l \left[ \log \frac{2l}{(r_g d^2)^{\frac{1}{3}}} - 1 \right] \quad (60)$$

The expression  $(r_g d^2)^{\frac{1}{2}}$  is the g. m. d. of the multiple conductor. For example, suppose in the last case  $l=1000$  cm,  $\rho=2$  mm,  $d=1$  cm. Then  $(r_g d^2)^{\frac{1}{2}}=0.538$  cm and

$$L = 2000 \left[ \log_e \frac{2000}{0.5380} - 1 \right]$$

$$= 2000 \times 7.221 \text{ cm} = 14.442 \text{ microhenrys.}$$

If the whole current flowed through a single one of the three conductors the self-inductance would be

$$L = 2000 \left[ \log_e \frac{2000}{0.2} - \frac{3}{4} \right] = 17.92 \text{ microhenrys,}$$

or about 25 per cent more than when divided among the three.

Guye has shown<sup>13</sup> how, by the principle of the geometrical mean distance, one can calculate very readily the self-inductance for any number of similar conductors in multiple when they are distributed in a circle, Fig. 25.

If there are  $n$  conductors uniformly spaced on a circle the geometrical mean distance  $R$  of the system is given by

$$\log R = \frac{n \log r_1 + n \log (r_{12} \cdot r_{13} \cdot \dots \cdot r_{1n})}{n^2}$$

$$= \frac{1}{n} (\log r_1 + \log (r_{12} \cdot r_{13} \cdot \dots \cdot r_{1n})) \quad (6I)$$

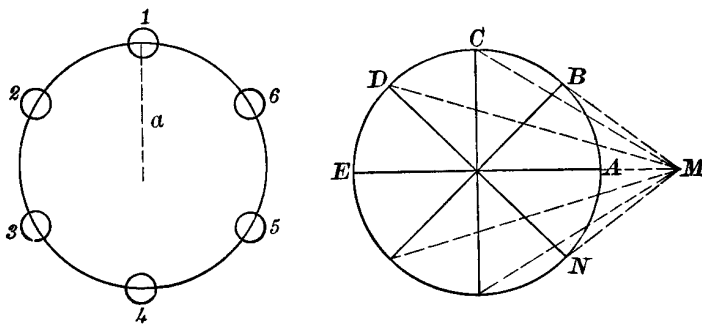

Fig. 25.

where  $r_1$  is the g. m. d. of a single conductor ( $=0.7788\rho$ ,  $\rho$  being its radius) and  $r_{12}$  is the distance between centers of the conductors 1 and 2, etc. If  $a$  is the radius of the circle on which the conductors are distributed

<sup>13</sup> C. E. Guye, Comptes Rendus, 118, p. 1329; 1894.

$$\log R = \frac{1}{n} \log (r_1 n a^{n-1})$$

$$\text{or } R = (r_1 n a^{n-1})^{\frac{1}{n}} \quad (62)$$

The proof of this, as given by Guye, depends on the following theorem:

If the circumference of a circle is divided into  $n$  equal parts by the points A, B, C, . . . and M be any point on the line through OA (inside or outside the circle), then putting  $OM = x$

$$x^n - a^n = MA \cdot MB \cdot \dots \cdot MN \quad (\text{Cotes's theorem}).$$

Dividing by  $MA = x - a$ ,

$$x^{n-1} + ax^{n-2} + \dots + a^{n-1} = MB \cdot MC \cdot \dots \cdot MN$$

Making M coincide with A, and hence  $x = a$ ,

$$\begin{aligned} na^{n-1} &= AB \cdot AC \cdot \dots \cdot AN \\ &= a_{12} \cdot a_{13} \cdot \dots \cdot a_{1n} \end{aligned}$$

which substituted in (61) gives (62).

Since the self-inductance of a length  $l$  of the multiple system is equal to

$$L = 2l \left[ \log \frac{2l}{R} - 1 \right] \quad (63)$$

we see that the calculation for any case is simple when  $\rho$ ,  $a$ , and  $n$  are given. Thus, suppose  $a = 2$  cm,  $\rho = 0.5$  cm, and  $n = 6$ ,

$$r_1 n a^{n-1} = 0.3894 \times 6 \times 32$$

$$\therefore R = (74.765)^{\frac{1}{6}} = 2.0525$$

If the separate conductors have only half the diameter supposed, namely,  $\rho = 0.25$ , the g. m. d.  $R$  will be considerably less. In this case

$$R = (0.1947 \times 192)^{\frac{1}{6}} = 1.8285 \text{ cm.}$$

Thus, in the first case, the self-inductance of the six parallel conductors is equal to that of a thin tube of radius 2.0525 cm, and in the second case to that of a tube of radius 1.8285 cm. As  $n$  increases and  $\rho$  decreases the value of  $R$  approaches 2 cm as a limit, the multiple conductors forming in the limit a tube of infinitesimal thickness, the value of  $R$  for which is its radius  $a$ , in this case 2 cm.

If a larger conductor at the center carries the going current, and the return is by the multiple conductor, the mutual inductance of the larger upon the others is

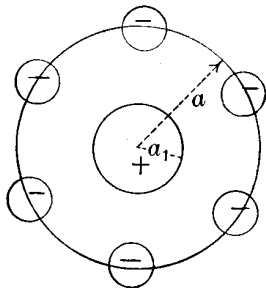

Fig. 26.

$$M = 2l \left[ \log \frac{2l}{a} - 1 \right] \quad (64)$$

since the g. m. d. of the central conductor on each of the others is  $a$ .

The self-inductance of the return system is

$$\begin{aligned} L &= L_1 + L_2 - 2M \\ \text{where} \quad L_1 &= 2l \left[ \log \frac{2l}{a_1} - \frac{3}{4} \right] \\ L_2 &= 2l \left[ \log 2l - \log (r_1 n a^{n-1})^{\frac{1}{n}} - 1 \right] \\ M &= 2l \left[ \log \frac{2l}{a} - 1 \right] \\ \therefore L &= 2l \left[ \log \frac{a^2}{a_1} - \log (r_1 n a^{n-1})^{\frac{1}{n}} + \frac{1}{4} \right] \end{aligned} \quad (65)$$

For  $a = 2$  cm,  $a_1 = 1$  cm,  $\rho = 0.5$ ,  $n = 6$ ,  $l = 1000$  cm

$$\begin{aligned} L &= 2000 \left[ \log_e 4 - \log_e (2.0525) + \frac{1}{4} \right] \\ &= 2000 \times 0.9173 = 1.835 \text{ microhenrys.} \end{aligned}$$

If the inner conductor were surrounded by a very thin tube of radius 2 cm for a return, in place of the six wires, the self-inductance of the return circuit would be

$$\begin{aligned} L &= 2000 \left[ \log \frac{a}{a_1} + \frac{1}{4} \right] \\ &= 2000 \times 0.9431 \text{ cm} = 1.886 \text{ microhenrys,} \end{aligned} \quad (66)$$

a little greater than in the preceding case.

If the central conductor is also a multiple system, Guye has shown<sup>13</sup> how to find the mutual inductance of the two when the arrangement is symmetrical, the g. m. d. of the two systems being derived by the aid of Cotes's theorem. In this case

$$\log R_{12} = \frac{1}{n} \log (a_2^n - a_1^n)$$

$$\text{or } R_{12} = (a_2^n - a_1^n)^{\frac{1}{n}} \quad (67)$$

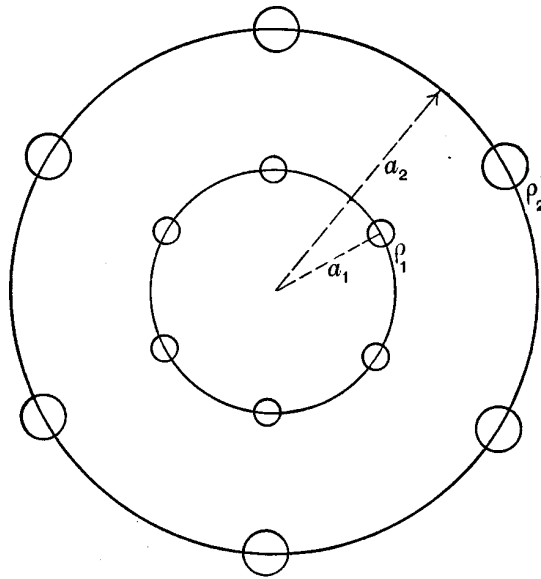

Fig. 27.

Thus, if  $a_2 = 2$  cm,  $a_1 = 1$  cm, and  $n = 6$ ,

$$R = (64 - 1)^{\frac{1}{6}} = 1.9947$$

and as  $n$  increases  $R_{12}$  approaches 2 as a limit, as it would be for two concentric tubes of radii 1 and 2.  $R_1$  and  $R_2$  for the two separate systems being given by (62) and  $R_{12}$  by (67), the self-inductance of a return circuit with one system for the going current and the other for the return is readily calculated, being

$$L = 2l \log \frac{R_{12}^2}{R_1 R_2} \quad (68)$$

These examples are sufficient to illustrate the calculation of the self and mutual inductance of multiple circuits by the principle of the geometrical mean distance.

## 20. SELF-INDUCTANCE OF A "NONINDUCTIVE" WINDING OF ROUND WIRES.

Suppose a to-and-fro winding of insulated wire in a plane, the length of each section being  $l$ , the distance apart of the adjacent

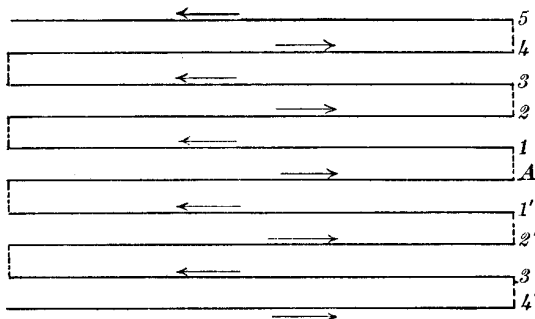

Fig. 28.

wires, center to center, being  $d$ , and the wire of radius  $\rho$ . The resultant self-inductance of one of the wires is equal to the self-inductance of the wire taken by itself plus the mutual inductance of all the others upon it. The mutual inductance of wires 2, 2', 4, 4', 6, 6', etc., upon wire A at the middle of the group tends to increase the self-inductance of A, while the mutual inductance of 1, 1', 3, 3', 5, 5', etc., tends to decrease the self-inductance of A. Hence, if  $L_1$  is the self-inductance of A by itself and  $M_1$  is the mutual inductance of wire 1 on A, etc., we have for  $L_A$  the total resultant self-inductance of wire A of length  $l$  the following expression:

$$\begin{aligned}
 L_A &= L_1 + 2M_2 + 2M_4 + 2M_6 + \dots + 2M_{n-1} - 2M_1 - 2M_3 \\
 &\quad - 2M_5 - 2M_7 - \dots - M_n \\
 &= (L_1 - M_1) - (M_1 - M_2) - (M_3 - M_4) - (M_5 - M_6) - \dots \\
 &\quad + (M_2 - M_3) + (M_4 - M_5) + (M_6 - M_7) + \dots \quad (69) \\
 &= 2l \left[ \log \frac{d}{\rho} + \frac{1}{4} \right] - 2l \log \frac{2}{1} - 2l \log \frac{4}{3} - 2l \log \frac{6}{5} - \dots \\
 &\quad + 2l \log \frac{3}{2} + 2l \log \frac{5}{4} + 2l \log \frac{7}{6} + \dots \\
 &= 2l \left[ \log \frac{d}{\rho} + \frac{1}{4} \right] - 2l \log \left( \frac{2 \cdot 4 \cdot 6 \cdot 8 \dots}{1 \cdot 3 \cdot 5 \cdot 7 \dots} \right) + 2l \log \left( \frac{3 \cdot 5 \cdot 7 \cdot 9 \dots}{2 \cdot 4 \cdot 6 \cdot 8 \dots} \right)
 \end{aligned}$$

$$= 2l \left[ \log \frac{d}{\rho} + \frac{1}{4} \right] - 2l \log \left( \frac{2^2 \cdot 4^2 \cdot 6^2 \cdot 8^2 \dots}{1^2 \cdot 3^2 \cdot 5^2 \cdot 7^2 \cdot 9^2 \dots} \right)$$

$$\text{or } L = 2l \left[ \log \frac{d}{\rho} + \frac{1}{4} - 2 \log \left( \frac{2 \cdot 4 \cdot 6 \cdot 8 \dots (n-1)}{1 \cdot 3 \cdot 5 \cdot 7 \dots (n-2) \sqrt{n}} \right) \right] \quad (70)$$

(where  $2n$  is the whole number of wires)

$$= 2l \left[ \log \frac{d}{\rho} + \frac{1}{4} - A \right] \quad (71)$$

where the constant  $A$  depends on the whole number of wires. Since

$$\frac{1 \cdot 3 \cdot 5 \cdot 7 \dots (2n-1)(2n+1)}{2^2 \cdot 4^2 \cdot 6^2 \dots (2n)^2} = \frac{\pi}{2}$$

when  $n$  is infinite,<sup>14</sup> we see that equation (70) becomes for an infinite number of wires

$$\begin{aligned} L &= 2l \left[ \log \frac{d}{\rho} + \frac{1}{4} - \log \frac{\pi}{2} \right] \\ &= 2l \left[ \log \frac{2d}{\pi\rho} + \frac{1}{4} \right] \end{aligned} \quad (72)$$

This formula (72) was first given by Mr. G. A. Campbell.<sup>15</sup> He has recently communicated to me by letter his (unpublished) demonstration, which is different from that given above and gives the value of  $L$  for an infinite number of wires and not for any finite number, which is the more important case.

For  $2n=2$ ,  $A = 0$

$$2n=4, A = \log_e 2 = .6931$$

$$2n=6, A = \log_e \frac{4}{3} = .2876$$

$$2n=10, A = \log_e \frac{64}{45} = .3522$$

$$2n=14, A = \log_e \frac{256}{175} = .3804$$

$$2n=18, A = 2 \log_e \frac{128}{105} = .3961$$

<sup>14</sup> Loney's Trigonometry II, p. 155.

<sup>15</sup> Elect. World, 44, p. 728; 1904. There is an error in this formula as originally printed; it should have  $l/2$  for coefficient instead of  $l$ .

$$2n = 38, A = \dots\dots = .4253$$

$$2n = 70, A = \dots\dots = .4373$$

$$2n = \infty, A = \log_{\epsilon} \frac{\pi}{2} = .4516$$

Thus we see that the resultant self-inductance of the middle wire of such a "noninductive" system is always less than that of a single pair, by the quantity  $2Al$ . If the winding is such that  $d = 3\rho$ ,  $\log_{\epsilon} \frac{d}{\rho} + \frac{1}{4} = 1.35$ , approximately, and the self-inductance of the middle wire is about two-thirds as much when there is a great number of such wires side by side as when there is a single pair, and about three-fourths as much if there are 10 such wires (5 pairs).

The self-inductance of the end wire will be more, being

$$\begin{aligned} L &= L_1 - M_1 + M_2 - M_3 + M_4 - \dots\dots \\ &= 2l \left[ \log_{\epsilon} \frac{d}{\rho} + \frac{1}{4} \right] + (M_2 - M_3) + (M_4 - M_5) + \dots\dots \\ &= 2l \left[ \log_{\epsilon} \frac{d}{\rho} + \frac{1}{4} + \log_{\epsilon} \left( \frac{3 \cdot 5 \cdot 7 \dots}{2 \cdot 4 \cdot 6 \dots} \right) \right] \\ &= 2l \left[ \log_{\epsilon} \frac{d}{\rho} + \frac{1}{4} - A_1 \right] \end{aligned}$$

where  $A_1 = -\log_{\epsilon} \frac{3}{2}$  for  $2n = 4$

$$= -\log_{\epsilon} \frac{15}{8} \text{ " } 2n = 6 \text{ etc.}$$

For the next to the end wire

$$L = 2l \left[ \log_{\epsilon} \frac{d}{\rho} + \frac{1}{4} - A_2 \right]$$

where  $A_2 = \log_{\epsilon} \frac{8}{3}$  for  $2n = 4$

$$= \log_{\epsilon} \frac{16}{5} \text{ " } 2n = 6, \text{ etc.}$$

For the second from end wire

$$A_3 = \log_{\epsilon} \frac{16}{15} \text{ for } 2n = 8$$



These examples show how the self-inductance of any particular wire of such a winding may be computed and the average or total value found. For a large number the average value of  $A$  would evidently not be far from 0.40.

#### 21. CASE OF NONINDUCTIVE WINDING ON A CIRCULAR CYLINDER.

The self-inductance of a single circular turn would be approximately

$$L_1 = 4\pi a \left[ \log \frac{8a}{\rho} - 1.75 \right]$$

where  $a$  is the radius of the circle and  $\rho$  is the radius of section of the wire. The mutual inductance  $M_1$  of two adjacent turns is

$$M_1 = 4\pi a \left[ \log \frac{8a}{d} - 2 \right], \text{ approximately,}$$

where  $d$  is the distance between centers of the two turns. This approximation is close only so long as  $d$  is small compared with  $a$ .

Similarly  $M_2 = 4\pi a \left[ \log \frac{8a}{2d} - 2 \right]$  and hence

$$M_1 - M_2 = 4\pi a (\log 2)$$

$$M_2 - M_3 = 4\pi a \left( \log \frac{4}{3} \right), \text{ etc.}$$

$$\begin{aligned} \therefore L_A &= L_1 - 2M_1 + 2M_2 - 2M_3 + M_4 \\ &= L_1 - M_1 - (M_1 - M_2) + (M_2 - M_3) - (M_3 - M_4) \\ &= 4\pi a \left[ \log \frac{d}{\rho} + \frac{1}{4} \right] - 4\pi a \left[ \log 2 - \log \frac{3}{2} + \log \frac{4}{3} \right] \text{ for } 2n = 8 \text{ turns} \\ &= 4\pi a \left[ \log \frac{d}{\rho} + \frac{1}{4} - 2 \log \left( \frac{2 \cdot 4 \cdot 6 \dots (n-1)}{1 \cdot 3 \cdot 5 \dots (n-2) \sqrt{n}} \right) \right] \text{ for } 2n \text{ turns} \\ &= 4\pi a \left[ \log \frac{d}{\rho} + \frac{1}{4} - A \right] \end{aligned} \tag{73}$$

where  $A$  has the same values as in the case of parallel straight wires laid noninductively in a plane, provided the length of the coil is small compared with the radius, so that the approximate formula

for  $M$  is sufficiently exact. The values of  $A$  are positive except for the end wire and depend on the number of wires and the position of the particular wire in the winding. If the radius is not large in proportion to the length of the coil, the constant  $A$  is a little less than for the wires in a plane. It is to be noted that the self-inductance of such a winding does not depend on the size of the wire, but on the ratio  $\frac{d}{\rho}$ , so that if a fine wire has a proportionally close spacing its self-inductance is the same. For a given pitch the self-inductance is of course greater as the wire is finer.

Taking  $A$  for the entire spool as approximately equal to 0.40 formula (73) becomes

$$L = 2l \left[ \log \frac{d}{\rho} - 0.15 \right] \text{ approximately} \quad (74)$$

where  $L$  is the self-inductance of a "noninductive" winding in a plane or on a cylinder of any radius,  $l$  being the total length of the wire,  $\rho$  is radius and  $d$  the mean distance between adjacent turns, center to center. In practice  $d/\rho$  can not be obtained with great precision, so that an accurate value of the constant  $A$  is not necessary. Moreover, the precise value of  $L$  for such a winding is seldom or never required.

A spool of 200 turns of wire with  $a = 1$  cm,  $d/\rho = 4$ , (taking  $A = 0.4$ ) would have a self-inductance of

$$\begin{aligned} L &= 4\pi a (\log_e 4 - 0.15) \times 200 \\ &= 800\pi (1.386 - 0.15) \\ &= 3100 \text{ cm} = 3.1 \text{ microhenrys.} \end{aligned}$$

Since deriving the above expressions Mr. Campbell has sent me an expression for the mean value of the constant  $A$  for a noninductive winding in a plane for any number of wires. His demonstration is as follows:

Take  $2n$  straight conductors, each of radius  $\rho$ , lying in a plane with adjacent wires at distance  $d$  center to center as before, the current traversing adjacent wires in opposite directions. We may regard this as a system of  $n$  circuits, each consisting of two adjacent wires. The total inductance will be equal to  $n$  times the self-inductance of one of the circuits plus  $2(n-1)$  times the mutual

inductance of two adjacent circuits plus . . . . . plus two times the mutual inductance of extreme circuits. That is, per unit of length of the system:

$$L = n \left( 4 \log \frac{d}{\rho} + 1 \right) + 2(n-1) 2 \log \frac{1.3}{2.2} + 2(n-2) 2 \log \frac{3.5}{4.4} + \dots$$

$$+ 2.2 \log \frac{(2n-3)(2n-1)}{(2n-2)(2n-2)}$$

$$= 4n \left( \log \frac{d}{\rho} + \frac{1}{4} \right) + 4 \log \left[ \left( \frac{1.3}{2.2} \right)^{n-1} \left( \frac{3.5}{4.4} \right)^{n-2} \dots \frac{(2n-3)(2n-1)}{(2n-2)(2n-2)} \right]$$

or for a total length of wire  $l$

$$L = 2l \left[ \log \frac{d}{\rho} + \frac{1}{4} - \frac{1}{n} \sum_{k=1}^{k=n-1} (n-k) \log \frac{4k^2}{4k^2-1} \right] \tag{75}$$

$$= 2l \left[ \log \frac{d}{\rho} + \frac{1}{4} - \log \frac{\pi}{2} + \frac{1}{4(n-1)} + \frac{0.5772 + \log(n-1)}{4n} \right] \text{approximately} \tag{76}$$

The value of the constant A of formula (71) as calculated by Mr. Campbell for various numbers of pairs of wires are given in the following table:

TABLE I.

The Constant A for Formula (71)

n	Value of A by Formula (75)	n	Value of A by Formula (75)
1	.000	10	.350
2	.144	15	.377
3	.213	20	.392
4	.255	25	.402
5	.283	30	.409
6	.304	100	.436
7	.319	200	.443
8	.332	300	.446
9	.342	Infinity	.452

As stated above, the constant  $A$  of formula (73) is very nearly the same as in (71), and hence the same values may be used for approximate calculations.

The above results by no means exhaust the subject of the self and mutual inductance of linear conductors; enough has been given, however, to serve in some measure as a guide in solving other cases arising in practice.

WASHINGTON, September 15, 1907.

O